

Ai-Motor

Endo Motor Instruction Manual

CE 0197

SGP

Please read this manual before operating



www.glwoodpecker.com

GUILIN WOODPECKER MEDICAL INSTRUMENT CO., LTD.

Contents

1 Product introduction.....	1
2 Installation	5
3 Function and operation of product	12
4 Operation instruction	15
5 Troubleshooting	28
6 Cleaning, Disinfection and Sterilization	29
7 Storage, maintenance and transportation	38
8 Environmental protection	39
9 After service	39
10 European authorized representative.....	39
11 Symbol instruction	39
12 Statement	40
13 EMC-Declaration of conformity.....	40

1 Product introduction

1.1 Preface

Guilin Woodpecker Medical Instrument Co., Ltd is a professional manufacturer researching, developing, and producing dental products. Woodpecker owns a sound quality control system. Guilin Woodpecker Medical Instrument Co., Ltd has two brands, Woodpecker and DTE. Its main products include Ultrasonic Scaler, Curing light, Apex locator, Ultrasurgery, Endo Motor, etc.

1.2 Product description

Ai-Motor Endo Motor is mainly used in Endodontic treatment. It is a cordless endo motor with root canal measurement capability. It can be used as a endo motor for preparation and enlargement of root canals, or device for measuring canal length. It can be used to enlarge the canals while monitoring the position of the file tip inside the canal.

Features:

- a) Efficient brushless motor, low noise, long service life.
- b) Cordless portable endo motor with combined length determination.
- c) 360 degrees rotation of contra angle.
- d) Adopt real-time feedback technology and dynamic torque control, effectively preventing file separation.

1.3 Model and specification

Ai-Motor

Please refer to packing list for device configurations.

1.4 Performance and composition

The device is composed of charging base, motor handpiece, contra angle, measuring wire, lip hook, file clip, power adapter, protective silicon cover, etc.

Ai-Motor

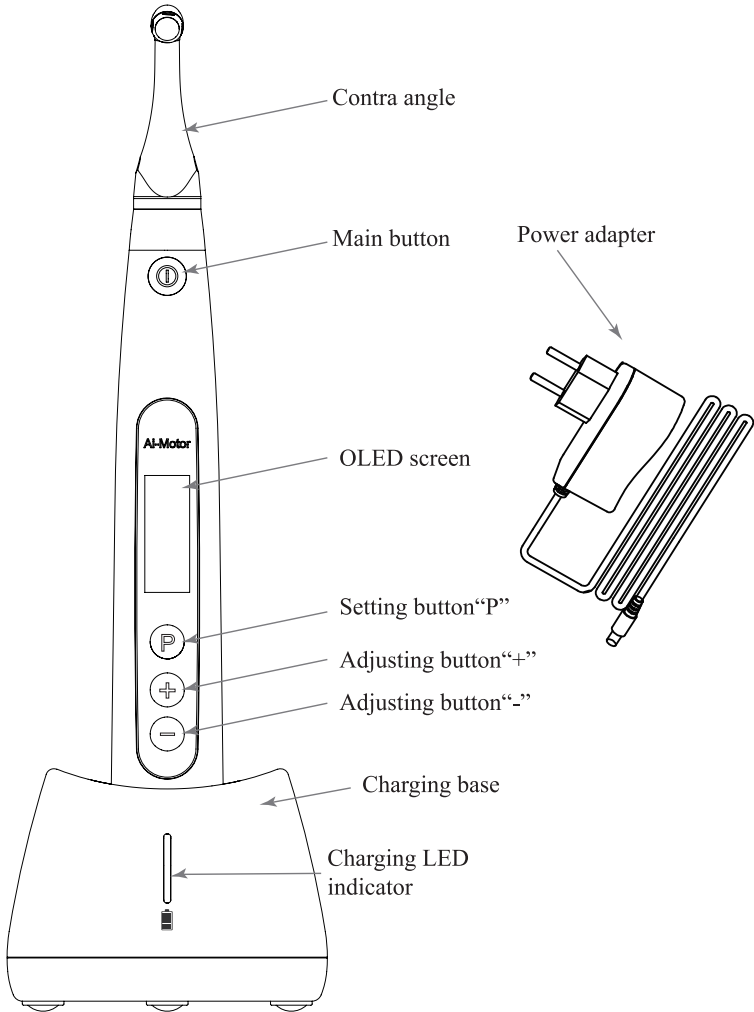

1.5 Indications for Use

Ai-Motor Endo Motor is cordless endodontic treatment motorized handpiece with root canal measurement capability. It can be used for

preparation and enlargement of root canals, or measuring the canal length.

And it can be used to enlarge the canals while monitoring the position of the file tip inside the canal.

1.6 Scope of application

The device must be operated in hospital and clinic by the qualified dentists.

1.7 Caution

Federal law restricts this device to sale by or on the order of a dentists.

1.8 Contraindication

- a) The doctor with a pacemaker is disabled.
- b) patients with cardiac pacemakers (or other electrical equipment) are warned not to use small appliances (such as Electric razors, hair dryers, etc.) patients are disabled.
- c) Hemophilia patients are banned.
- d) Use with caution in patients with heart disease, pregnant women and young children.

1.9 Warnings

1.9.1 Please carefully read this Instruction Manual before first operation.

1.9.2 This device should be operated by professional and qualified dentist in qualified hospital or clinic.

1.9.3 Do not directly or indirectly place this device near heat source. Operate and store this device in reliable environment.

1.9.4 This device requires special precautions regarding electromagnetic compatibility (EMC) and must be in strict accordance with the EMC information for installation and use. Do not use this equipment especially in the vicinity of fluorescent lamps, radio transmitting devices, remote control devices, handheld and mobile high-frequency communication devices.

1.9.5 Please use the original contra angle. Otherwise it will not be used or cause adverse consequences.

1.9.6 Please do not make any changes to the device. Any changes may violate safety regulations, causing harm to the patient. There will be no promises of any modification.

1.9.7 Please use original power adapter. Other power adapter will result in damage to lithium battery and control circuit.

1.9.8 The motor handpiece cannot be autoclaved. Use disinfectant of neutral pH value or ethyl alcohol to wipe its surface.

1.9.9 Before the contra angle stopping rotating, do not press the push cover of contra angle. Otherwise the contra angle will be broken.

1.9.10 Before the motor handpiece stopping rotating, do not remove the contra angle. Otherwise the contra angle and the gear inside motor handpiece will be broken.

1.9.11 Please confirm whether the file is well installed and locked before starting the motor handpiece.

1.9.12 Please set torque and speed as per the recommended specifications of file manufacturer.

1.9.13 Error in replacing lithium batteries can lead to unacceptable risks, so use the original lithium battery and replace the lithium battery according to the correct steps in the instructions.

1.9.14 Please remove the battery if the motor handpiece is not likely to be used for some time.

1.9.15 Wireless charging will generate heat, and the surface temperature of charging base and motor handpiece will rise. It is recommended that the time of contacting motor handpiece and charging base during wireless charging should not exceed 10 seconds.

1.9 Device safety classification

1.9.1 Type of operation mode: Continuous operating device

1.9.2 Type of protection against electric shock: Class II equipment with internal power supply

1.9.3 Degree of protection against electric shock: B type applied part

1.9.4 Degree of protection against harmful ingress of water: Ordinary equipment (IPX0)

1.9.5 Degree of safety application in the presence of a flammable anesthetic mixture with air, oxygen, or nitrous oxide: Equipment cannot be used in the presence of a flammable anesthetic mixture with air, oxygen, or nitrous oxide.

1.9.6 Applied part: contra angle, lip hook, file clip, touch probe.

1.9.7 The contact duration of applied part: 1 to 10 minutes.

1.9.8 The temperature of the surface of applied part may reach 46.6°C.

1.10 Primary technical specifications

1.10.1 Battery

Lithium battery in motor handpiece: 3.7V /2000mAh

1.10.2 Power adapter (Model: ADS-6AM-06N 05050/UE08WCP-

050100SPA)

Input: ~100V-240V 50Hz/60Hz 0.4A Max

Output: DC5V/1A

1.10.3 Torque rang: 0.4Ncm-5.0Ncm (4mNm ~ 50mNm)

1.10.4 Speed rang: 100rpm~1200rpm

1.10.5 Wireless charging

Frequency range: 112-205KHz

Maximum RF output power of the product: 9.46dBuA/

m@3m

1.11 Environment parameters

1.11.1 Environment temperature: +5°C ~ +40°C

1.11.2 Relative humidity: 30% ~ 75%

1.11.3 Atmospheric pressure: 70kPa ~ 106kPa

2 Installation

2.1 Basic accessories of product

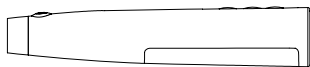

Motor handpiece



Contra angle

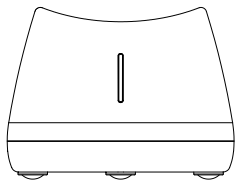

Charging base



Nozzle

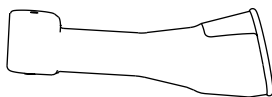

Protective silicon cover

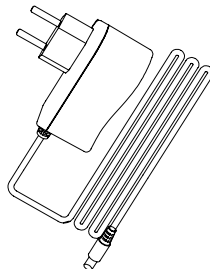

Power adapter

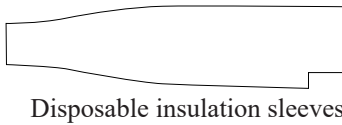
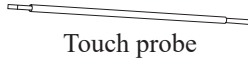
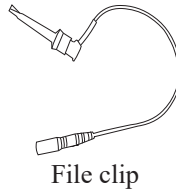
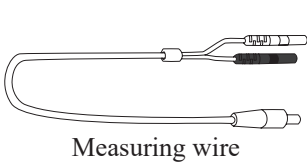

2.2 Display Screens

2.2.1 Display Screens for 5 Operation Modes and Standby

2.2.1.1 EAL Mode

This mode is for canal measurement. The motor handpiece does not run in this mode.



2.2.1.2 CW Mode

The motor handpiece rotates forward 360°, clockwise direction. Used rotary files likes WOODPECKER W3-Pro.

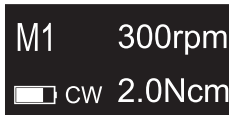

2.2.1.3 CCW Mode

The motor handpiece rotates counterclockwise direction only. This mode is used to inject calcium hydroxide and other medicant. When this mode is being used, a double-beep sounds continuously.



2.2.1.4 SGP Mode

Safety Glide Path Mode

F: Forward angle, R: Reverse angle

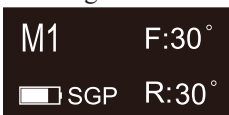

The rotation angle is adjustable, but the forward angle must be equal to the reverse angle.

2.2.1.5 ATR Mode

ATR: Adaptive Torque Reverse function.

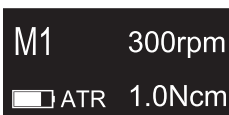

Normal continuous forward rotation, when the load of the file is greater than the set torque limit, the file will start to rotate alternately at the set angle.

2.2.2 Torque Display

This appears when the motor is running. Meter shows the torque load on the file.

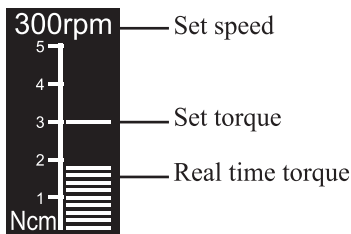

2.2.3 Canal Measurement Display

This appears when a file is inside the canal and the lip hook is contacting the patient mouth. Bars in meter show the location of the file tip. In the EAL Mode, If the length is less than 1.0, the display will be enlarged.

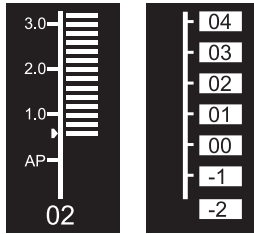

The meter numbers 1.0, 2.0, 3.0 and digital numbers 00-16 do not represent the actual length from the apical foramen. It simply indicates the file progression towards the apex. The digital numbers -1 and -2 indicate that the file has passed the apex foramen. The digital number “00” indicate that the file has reached the apex foramen. Subtract 0.5-1mm from the measured file length as the working length. These numbers are used to estimate the canal’s working length.

2.3 Instructions for contra angle

2.3.1 The contra angle adopts precision gear transmission, and the transmission ratio is 6:1.

2.3.2 Before the first use and after treatments, please clean and disinfect contra angle with disinfectant of neutral PH value. After disinfection, lubricate it with specific cleaning oil. Finally, sterilize it under high temperature and high pressure (134°C, 2.0bar~2.3bar (0.20MPa~0.23MPa)).

2.3.3 The contra angle can only be used cooperatively with this device. Otherwise the contra angle will be damaged.

2.4 Installation and removal of contra angle.

2.4.1 Installation

Align any locating pin of the contra-angle with the positioning slot on the motor handpiece and push the contra-angle horizontally. The three locating pins on the contra-angle are inserted into those three positioning holes on the motor handpiece. A “click” sound indicates that the installation is in place. The contra-angle can be rotated 360° freely.

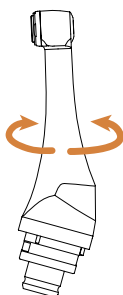
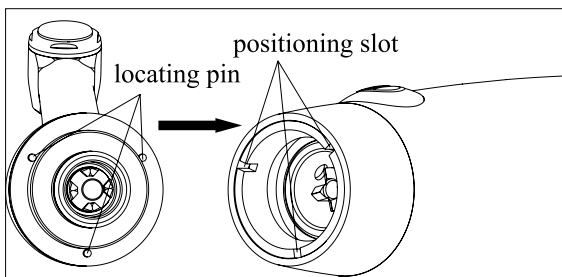

The contra-angle is free to rotate, adapting to the root canal of different positions, and it is convenient to watch the screen when operating.

2.4.2 Removal

Pull out the contra angle horizontally when the motor handpiece does not run.

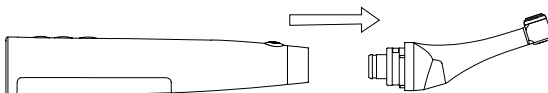

Warnings:

- a) Before plugging in or pulling out contra angle, please first stop the motor handpiece.
- b) After installation, please check and confirm that the contra angle has been well installed.

2.5 Installation and removal of file

2.5.1 Installation of file

Before starting the device, plug the file into the hole of contra angle head.

Hold down the push button on the contra angle and insert the file. Turn the file back and forth until it is lined up with interior latch groove and

slips into place. Release the button to lock the file into the contra angle.
Push Button

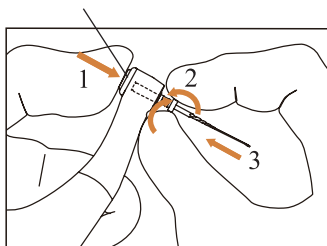

! Warnings:

After plugging the file into contra angle, let go the hand on push cover to assure that the file cannot be taken out.

Be careful when inserting files to avoid injury to fingers.

Inserting and removing files without holding the push button may damage the chuck of contra angle.

Please use files with shanks meet the ISO standard. (ISO standard: $\text{Ø}2.334 - 2.350 \text{ mm}$)

2.5.2 Removal of file

Pressing the push cover, and then directly pull out the file.

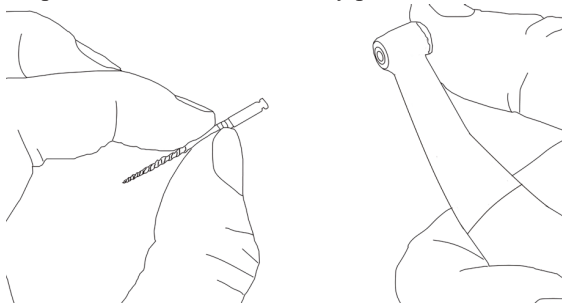

! Warnings:

Before plugging and pulling out the file, the motor handpiece must be stopped.

Be careful when removing files to avoid injury to fingers.

Removing files without holding the push button will damage the chuck of contra angle.

2.6 Canal measurement functional connection

This is not required if the canal measurement function will not be used.

Connect the measuring wire to the motor handpiece. Line up the measuring wire plug with the notch on the back of the motor and push it all the way in.

Connect the file clip plug into the socket (black) on the measuring wire. Connect the lip hook to the socket (white) on the measuring wire.

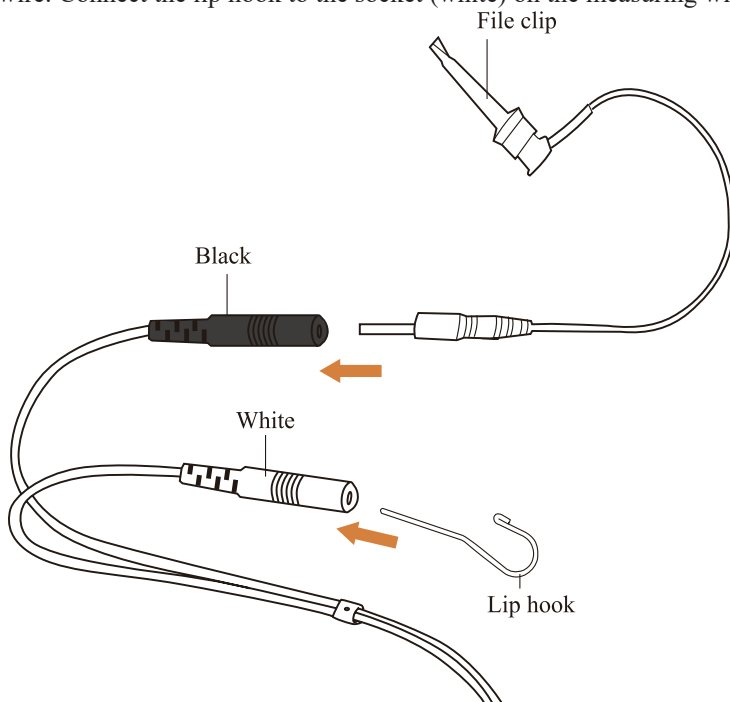

Warnings:

Connect the lip hook to the socket (white) on the measuring wire. Otherwise, the function of root canal preparation and root canal length measurement cannot be used together.

2.7 Installation and removal of disposable insulation sleeves

2.7.1 Installation

Before each use of the handpiece and after the handpiece is cleaned and disinfected, put on a disposable isolation sleeve. Take the isolation

sleeve out of the isolation sleeve box, then insert the isolation sleeve into the motor handpiece from the thin end of the handpiece, and install the isolation sleeve until there is no obvious wrinkle.

After installing the disposable isolation sleeve, wrap the barrier film around the handpiece surface. After that, clean and disinfect the surface of the handpiece. Refer to Chapter 6.3 for cleaning and disinfection procedures.

2.7.2 Removing

After each use, remove the barrier film and slowly pull the isolation sleeve from the thin end of the handpiece.

 **Warning:** Isolation sleeves are not reusable

3 Function and operation of product

3.1 Button definition and settings

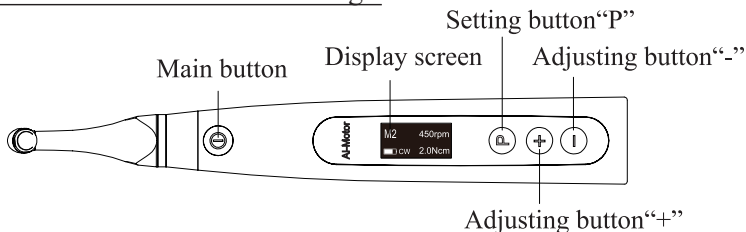

a. Turn power on

Press Main button to turn on motor handpiece.

b. Turn power off

Hold down the Setting button “P”, then press Main button to turn off motor handpiece.

c. Customized program change

Press Adjusting button “+”/“-” during standby state.

d. Parameter setting

Press Setting button “P” till target parameters, press Adjusting button “+”/“-” to change, then press Main button or wait 5 seconds to confirm.

e. Preset program selection

Long press Setting button “P” to entry preset program during standby state, press Adjusting button “+”/“-” to select file system , press Setting button “P” to entry select file number, press Adjusting button “+”/“-” to select file number, then press Main button to confirm.

f. Handpiece functions setting

With the motor handpiece turned off, hold down the Setting button “P” and press Main button to entry handpiece functions setting, press Setting button “P” till target setting, press Adjusting button “+”/“-” to adjust, then press Main button to confirm.

3.2 Screen display

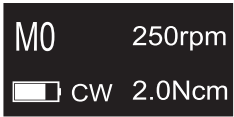
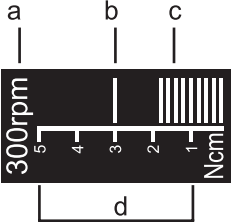
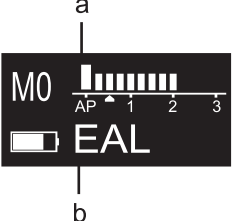
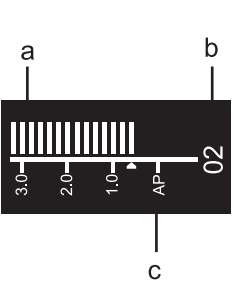
 <p>The standby interface shows a black screen with white text. At the top left is 'M0' and at the top right is '250rpm'. Below 'M0' is a battery icon and the text 'CW'. To the right of the battery icon is '2.0Ncm'. A small white bar is visible above the battery icon. Labels 'a' through 'e' point to these elements: 'a' to 'M0', 'b' to the battery icon, 'c' to '250rpm', 'd' to '2.0Ncm', and 'e' to the small white bar.</p>	<p>Standby interface</p> <ol style="list-style-type: none"> Customized program sequence number 0-9, totally 10 programs. Battery consumption Set speed Set torque Operation mode
 <p>The working interface shows a black screen with white text and graphics. On the left, '300rpm' is displayed vertically. Below it is a scale from 5 to 1. On the right, 'Ncm' is displayed vertically. Below it is a scale from 2 to 1. A horizontal bar with vertical segments is shown between the two scales. Labels 'a' through 'd' point to these elements: 'a' to '300rpm', 'b' to the top of the bar, 'c' to the right side of the bar, and 'd' to the bottom of the bar.</p>	<p>Working interface</p> <ol style="list-style-type: none"> Set speed Set torque Real time torque Torque display scale
 <p>The canal measurement mode interface shows a black screen with white text. At the top left is 'M0'. Below it is a bar chart with 10 segments. Below the bar chart is 'AP' with an upward arrow, and '1' and '2' are marked on the x-axis. At the bottom left is a battery icon and the text 'EAL'. Label 'a' points to the bar chart, and label 'b' points to the battery icon.</p>	<p>Canal measurement mode interface</p> <ol style="list-style-type: none"> Apical reference point flash bar EAL: Electronic apex locator
 <p>The canal measurement state interface shows a black screen with white text. At the top left is a bar chart with 10 segments. Below it is a scale from 3.0 to 1.0. At the bottom left is 'AP' with an upward arrow. At the bottom right is '02'. Label 'a' points to the bar chart, label 'b' points to '02', and label 'c' points to 'AP'.</p>	<p>Canal measurement state interface</p> <ol style="list-style-type: none"> Canal length indicator bar Indication number <p>Digital numbers 00-16 do not represent the actual length from the apical foramen. It simply indicates the file progression towards the apex. Number “00” indicate that the file has reached the apical foramen.</p> <ol style="list-style-type: none"> Apical foramen.

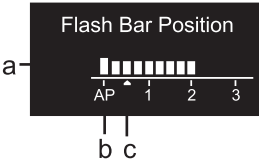
 <p>The diagram shows a horizontal scale labeled 'Flash Bar Position'. The scale has markings for 'AP', '1', '2', and '3'. A vertical line labeled 'a' is at the 'AP' position. A vertical line labeled 'b' is between 'AP' and '1'. A vertical line labeled 'c' is between '1' and '2'. There are several vertical bars of varying heights along the scale, with the tallest bar at the 'AP' position.</p>	<p>Apical reference point setting interface</p> <p>a. Apical reference point flash bar</p> <p>b. Apical foramen</p> <p>c. Digital “02” meter reading, very near physiological apical foramen.</p>
--	---

3.3 Terms and definition

CW	Clockwise rotation, forward rotation Be applied to rotary file
CCW	Counter clockwise rotation, reverse rotation Be applied to special file, inject calcium hydroxide and other solutions
SGP	Safety Glide Path Mode
ATR	Adaptive torque reverse Up to setting torque, the motor will move with ATR mode ; when torque reduce to normal value, the motor will clockwise rotate.
Forward Angle	Angle of clockwise rotation of the file .
Reverse Angle	Angle of counter clockwise rotation of the file .
EAL	Electronic apex locator In the mode, the device will work like a stand-alone apex
AP	Apical foramen.
Apical Action	The file action when file tip reaches the flash bar point.
Flash Bar Position	Shows the point inside the canal where specified apical action is triggered.
Auto Start	The file rotation starts automatically when the file is inserted in the canal.
Auto Stop	The file rotation stops automatically when the file is taken out of the canal.
Apical Slow Down	The file slows down automatically as it approaches the apex. Activating in CW and CCW operation mode.

Operation Mode	5 operation modes for canal shaping and measurement. Such as CW, CCW, SGP, ATR and EAL.
Speed	File rotation speed.
Torque (Torque Limit / Trigger Torque)	For CW and CCW modes, the torque value (Torque Limit) that triggers reverse rotation. For ATR mode, the torque value (Trigger Torque) that triggers ATR action.

4 Operation instruction

4.1 Power on and power off

4.1.1 Starting and stopping of motor handpiece

a) Under the power off state of motor handpiece, press Main button, and then the motor handpiece will enter Standby interface. The interface displays are as follow:

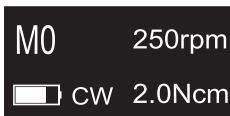

Standby interface

b) Under Standby interface, press Main button, and then the motor handpiece will enter Working interface. The interface displays are as follow:



Working interface

c) Press the Main button again, and then the motor handpiece backs to Standby interface.

d) Hold down the Setting button “P”, then press Main button to turn off motor handpiece. In Standby Interface, the motor handpiece would automatically shut down after 3 minutes without any button-pressing operation. The motor handpiece will also automatically shut down while it is put into the charging base.

4.2 Selecting customized program sequence number

The motor handpiece has 10 memory programs(M0-M9) and 5 preset

programs, press Adjusting button “+”/“-” to change customized program sequence number during standby state.

M0-M9 is a memory program for canal shaping and measurement, every memory program has its own parameters such as Operation mode, speed and torque, all these parameters can be changed.



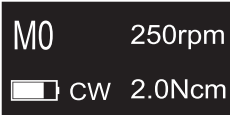
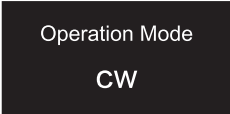
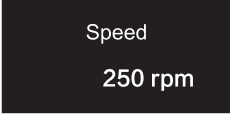

4.3 Parameter setting

 <p>M0 250rpm <input type="checkbox"/> CW 2.0Ncm</p>	<p>Before starting of motor handpiece, please check the operation mode is correct. All the parameters must be set according to files, make sure all the parameters are expected before starting of motor handpiece, otherwise has risk of file separate.</p>
 <p>Operation Mode CW</p>	<p>It has 5 operation modes for canal shaping and measurement: CW, CCW, SGP, ATR and EAL(See chapter 3.3 Terms and definition to get the explanations of these modes.) Press Setting button “P” once during standby state, press Adjusting button “+”/“-” to select correct Operation mode. CCW mode is used to inject calcium hydroxide and other medicant. When this mode is being used, a double-beep sounds continuously, used for indicating counter clockwise rotation happening.</p>
<p>Repeatedly press Setting button “P” to check all the next level parameters of this operation mode are expected, press Adjusting button “+”/“-” to select if not.</p>	
 <p>Speed 250 rpm</p>	<p>The speed setting can be adjusted from 100 rpm to 1200 rpm. Press Adjusting button “+”/“-” to increase or decrease speed. Long press to fast increase or fast decrease speed. In ATR mode, speed of 100~500rpm are available. In SGP mode, speed of 100~500rpm are available.</p>

<p>Torque Limit</p> <p>2.0 Ncm</p>	<p>The torque setting can be adjusted from 0.4Ncm to 5.0Ncm.</p> <p>Press Adjusting button “+”/“-” to increase or decrease torque. Long press to fast increase or fast decrease torque.</p> <p>In ATR mode, the Trigger Torque of 0.4Ncm~4.0Ncm are available.</p> <p>In SGP mode, the torque of 2.0Ncm~5.0Ncm are available.</p>
<p>Apical Action</p> <p>OFF</p>	<p>Actions that happen automatically when the file tip reaches the point inside the canal determined by the Flash Bar setting.</p> <p>Benefit from integration of length determination, when the file reaches the reference point, the motor will response according to setting, it can be Reverse , Stop and OFF.</p> <p>Press Adjusting button “+”/“-” to change.</p> <p>OFF: Disable Apical Action function, file rotating as usual even if reach the reference point.</p> <p>Stop: automatically rotation stop when reach the reference point, upward a little bit and will rotate again.</p> <p>Reverse: automatically reverses rotation when reach or pass the reference point, upward a little bit, the rotation direction will change back again.</p>
<p>Auto Start</p> <p>OFF</p>	<p>Rotation starts automatically when the file is inserted into the canal and the canal length indicator bar lights up more than 2 bars.</p> <p>Press Adjusting button “+”/“-” to change.</p> <p>OFF: Motor does not start when file is inserted into the canal. The Main button is used to start and stop the motor handpiece.</p> <p>ON: Motor starts automatically.</p>

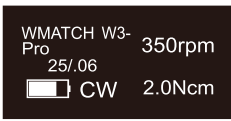
<p style="text-align: center;">Auto Stop</p> <p style="text-align: center;">OFF</p>	<p>Rotation stops automatically when the file is taken out of the canal and the canal length indicator bar lights up less than 2 bars before the file is taken out.</p> <p>Press Adjusting button “+”/“-” to change.</p> <p>OFF: Motor does not stop when file is taken out the canal. The Main button is used to start and stop the motor handpiece.</p> <p>ON: Motor stops automatically.</p>
<p style="text-align: center;">Flash Bar Position</p>  <p>The diagram shows a horizontal scale with four segments labeled AP, 1, 2, and 3. Above the scale, a series of five vertical bars of varying heights represent the flash bar position. The bars are positioned between the 1 and 2 marks, with the tallest bar centered between them.</p>	<p>This is the reference point where various apical actions are triggered.</p> <p>Press Adjusting button “+”/“-” to select reference point by change the flash bar.</p> <p>The meter’s 0.5 reading indicates that the file tip is located very near the physiological apical foramen.</p> <p>The reference point (flash bar) can be set from 2 to AP (Apex) on the meter.</p>
<p style="text-align: center;">Apical Slow Down</p> <p style="text-align: center;">OFF</p>	<p>Rotation automatically slows down as the file tip approaches the reference point.</p> <p>Press Adjusting button “+”/“-” to change.</p> <p>OFF: Disable Apical Slow Down function.</p> <p>ON: Rotation automatically slows down as the file tip approaches the reference point.</p>
<p style="text-align: center;">Forward Angle</p> <p style="text-align: center;">30°</p> <p style="text-align: center;">Reverse Angle</p> <p style="text-align: center;">30°</p> <p style="text-align: center;">M1 F:30°</p> <p style="text-align: center;">SGP R:30°</p>	<p>Forward Angle .In the REC mode, the Forward Angle of 20°~400° are available.</p> <p>In the ATR mode, the Forward Angle of 60°~400° are available.</p> <p>Reverse Angle .In the REC mode, the Reverse Angle of 20°~400° are available.</p> <p>In the ATR mode, the reverse Angle cannot be greater than the forward Angle.</p>

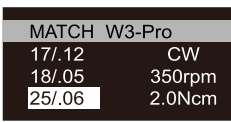
4.4 Preset program selection

	<p>For convenience, we preset some common file system.</p> <p>Press Adjusting button “+”/“-” to switch to preset program(M0-M9, preset program 1-5), the interface will show as left.</p>
	<p>Long press Setting button “P” to entry preset program during standby state, the interface will show as left.</p> <p>Press Adjusting button “+”/“-” to select file system.</p>
	<p>After select file system, press Setting button “P” to entry select file number, press Adjusting button “+”/“-” to select file number, then press Main button to confirm.</p>
	<p>The parameters of "W3-Pro" can also be changed make it different from default setting.</p> <p>If want to change back to default setting, long press Setting button “P” to entry preset program during standby state, select "W3-Pro" and press "Main" button to confirm, the default setting will be reloaded, Turn off the motor handpiece and then power on, the preset program can also restore the default setting.</p> <p>Changing the preset program default setting is not recommended, otherwise has risk of file separate.</p>

4.5 Handpiece functions setting

With the motor handpiece turned off, hold down the Setting button “P” and press Main button to entry handpiece functions setting, press Setting button “P” till target setting, press Adjusting button “+”/“-” to adjust, then press Main button to confirm.

	<p>With the motor handpiece turned off, hold down the Setting button “P” and press Main button to entry handpiece functions setting, the software version number will appear on the display screen.</p>
---	---

<p style="text-align: center;">Auto Power OFF 5 min</p>	<p>After 3 seconds of displaying the version number on the screen, the "Auto Power OFF" can be change, press Adjusting button "+" / "-" to adjust, then press to "Main" button to confirm. No buttons are pressed, auto power off time of motor handpiece. It can be set from 3 to 30 minutes in 1 minute increments.</p>
<p style="text-align: center;">Auto Standby Scr 30 sec</p>	<p>Press Setting button "P" again, the "Auto Standby Scr" can be change, press Adjusting button "+" / "-" to adjust, then press to "Main" button to confirm. No buttons are pressed, auto return to standby display of motor handpiece. It can be set from 3 to 30 seconds in 1 second increments.</p>
<p style="text-align: center;">Dominant Hand Right</p>	<p>Press Setting button "P" again, the "Dominant Hand" can be change, press Adjusting button "+" / "-" to adjust, then press to "Main" button to confirm. The right hand and the left hand can be set.</p>
<p style="text-align: center;">Calibration OFF</p>	<p>Press Setting button "P" again, the "Calibration" can be change, press Adjusting button "+" / "-" to select "ON", then press to "Main" button to calibration. Before calibrating, making sure the original contra angle is installed, and do not install the file. The torque will not correct if calibration without original contra angle or any load on contra angle chuck, and has risk of file separate. After replacement of contra angle, the contra angle shall be calibrated before use.</p>
<p style="text-align: center;">Beeper Volume Vol.3</p>	<p>Press Setting button "P" again, the "Beeper Volume" can be change, press Adjusting button "+" / "-" to adjust, then press to "Main" button to confirm. The "Beeper Volume" can be set from 0-3. Vol.0: Mute.</p>

Restore Defaults

OFF

Press Setting button "P" again, the "Restore Defaults" can be change, press Adjusting button "+"/"-" to select "ON", then press to "Main" button to restore defaults.

4.6 Protective function of automatic reverse

During operation, if the load value exceeds the preset torque value, the file rotation mode will automatically change to Reverse Mode. And the file would return to normal rotation mode when the load is below the preset torque value again.

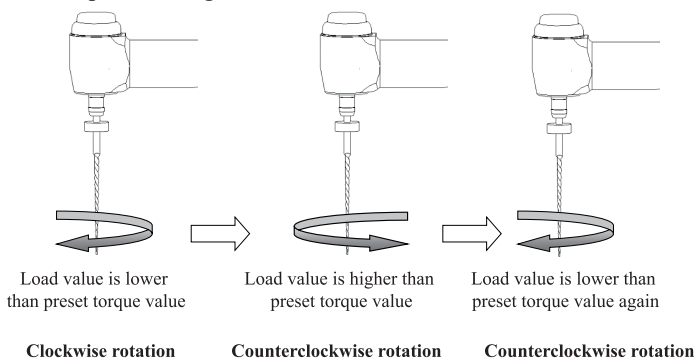

Cautions:

1. Protective function of automatic reverse is ONLY suitable for CW mode.
2. This function is forbidden under CCW mode, ATR mode.
3. When the motor handpiece battery indicator indicates a low battery capacity, the low battery capacity is insufficient to support the motor handpiece to reach the limit torque value, that is, the auto-reverse function will not work properly. Please charge it in time.
4. If the motor handpiece is under load all the time, the machine may stop automatically as a result of overheat protection. If it happens, turn off the motor handpiece for a while until the temperature drops.

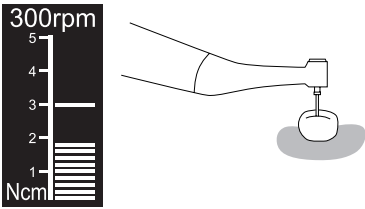
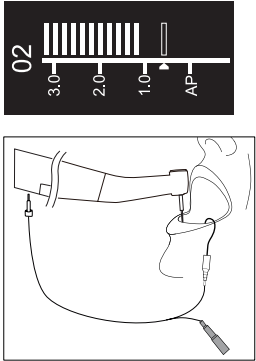
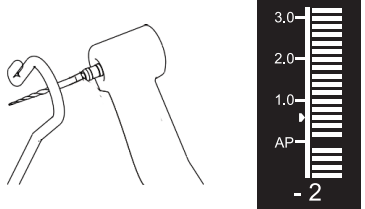

4.7 Motor operation

Please set operation mode, torque and speed as per the recommended specifications of file manufacturer.

	<p>Motor alone mode</p> <p>When using as motor alone mode, the torque bar will show on the screen.</p> <p>(more information about torque bar, please see chapter 3. 2 Screen display)</p>
	<p>Motor combined canal measurement function mode</p> <p>When using motor combined canal measurement function, the measuring wire must be connecting with motor handpiece by USB socket, and white socket connects with patient's lip by lip hook, keep the black socket idle.</p> <p>The canal length indicator bar will show on the screen (more information about canal length indicator bar, please see chapter 3. 2 Screen display)</p> <p>Setting parameters of automatic functions as needed, such as Apical Action, Auto Start, etc(more information about automatic functions, please see chapter 4.3 Parameter setting).</p>
	<p>Connection testing</p> <p>Strongly recommend check the connection testing every time before use. Touch the lip hook with the file in the contra angle and check that all the bars on the meter on the screen light up, and the motor should be reversed continuously, otherwise, the measuring wire or contra angle should be replace.</p>

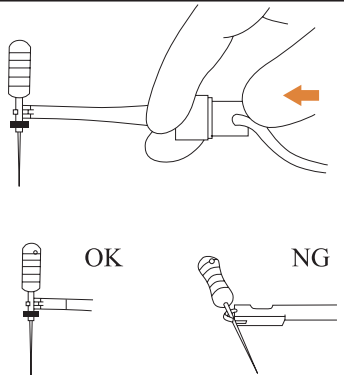
4.8 Canal measurement operation

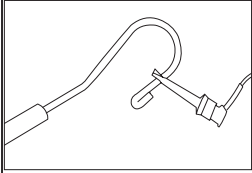
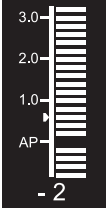
	<p>When using as alone apex locator mode. We suggest put the motor handpiece on the charging base to get better visual angle.</p> <p>Press Setting button “P” once during standby state, press Adjusting button “+”/“-” to select EAL Operation mode, then press Main button to confirm. (See chapter 3.3 Terms and definition to get the explanations of Operation modes.)</p> <p>The measuring wire must be connecting with motor handpiece by USB socket, white socket connects with patient’s lip by lip hook, and black socket connect with file clip.</p> <p>The canal length indicator bar will show on the screen (more information about canal length indicator bar, please see chapter 3. 2 Screen display).</p>
	<p>The file clip must hold the file correctly. Push the button on the file clip with your thumb in the direction shown by the arrow. Clip the holder onto the metal upper part of the file and then release the button.</p>

 	<p>Connection testing</p> <p>Strongly recommend check the connection testing every time before use. Clip the holder onto lip hook and check that all the bars on the screen light up, otherwise, the measuring wire or file clip should be replace.</p>
<p>Root canals not suitable for canal measurement</p> <p>Accurate measurement cannot be obtained if the root canal conditions shown below.</p>	
	<p>Root canal with a large apical foramen</p> <p>Root canal that has an exceptionally large apical foramen due to a lesion or incomplete development cannot be accurately measured. The results may show shorter measurement than the actual length.</p>

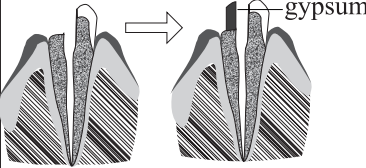
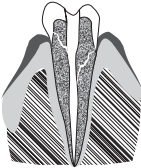
	<p>Root canal with blood overflowing from the opening</p> <p>If blood overflows from the opening of the root canal and contacts the gums, this will result in electrical leakage and an accurate measurement cannot be obtained. Wait for bleeding to stop completely. Clean the inside and opening of the canal thoroughly to get rid of all blood, and then make a measurement.</p> <p>Root canal with a chemical solution overflowing from the opening</p> <p>An accurate measurement cannot be obtained if some chemical solution is overflowing from the canal opening. In this case, clean the canal and its opening.</p> <p>It is important to get rid of any solution overflowing the opening.</p>
	<p>Broken crown</p> <p>If the crown is broken and a section of the gingival tissue intrudes into the cavity surrounding the canal opening, contact between the gingival tissue and the file will result in electrical leakage and an accurate measurement cannot be obtained. In this case, build up the tooth with a suitable material to insulate the gingival tissue.</p>
	<p>Fractured tooth</p> <p>Leakage through a branch canal</p> <p>Fractured tooth will cause electrical leakage and an accurate measurement cannot be obtained.</p> <p>A branch canal will also cause electrical leakage.</p>

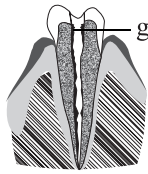
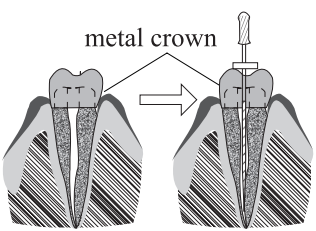
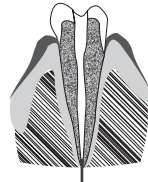
	<p>Re-treatment of a root filled with gutta-percha</p> <p>The gutta-percha must be completely removed to eliminate its insulating effect. After removing the gutta-percha, pass a small file all the way through the apical foramen and then put a little saline in the canal, but do not let it overflow the canal opening.</p>
	<p>Crown or metal prosthesis touching gingival tissue</p> <p>Accurate measurement cannot be obtained if the file touches a metal prosthesis that is touching gingival tissue. In this case, widen the opening at the top of the crown so that the file will not touch the metal prosthesis before taking a measurement.</p>
 <p>Too dry</p>	<p>Extremely dry canal</p> <p>If the canal is extremely dry, the meter may not move until it is quite close to the apex. In this case, try moistening the canal with saline.</p>

Difference measuring result between apex locator reading and radiography

Sometimes the reading of apex locator and the X-ray image will not correspond. This does not mean that the apex locator is not working properly or that the X-ray exposure is a failure. An X-ray image might not show the apex correctly depending on the angle of the X-ray beam, and the location of the apex might seem to be other than it really is.

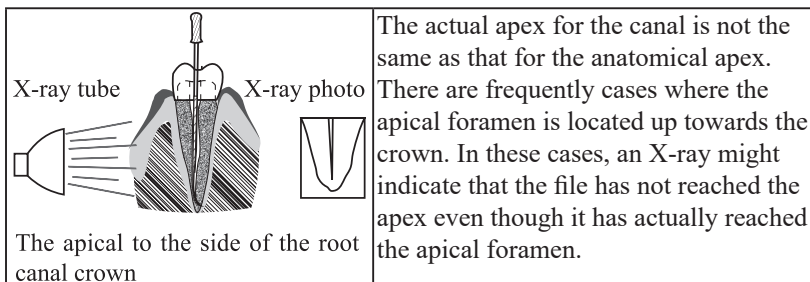

4.9 Battery Charging

The motor handpiece has built-in rechargeable lithium battery.

Insert the power adapter plug into the charging base power socket and confirm that they are correctly connected. Then insert the motor handpiece into the charging base (the motor handpiece needs to be correctly aligned with the charging base in the same direction for charging). When the blue indicator on the charging base flashes, it is charging. When the motor handpiece is fully charged, the blue indicator on the charging base would be always on.

After charging, please unplug the power adapter.

4.10 Replacing Battery

Replace the battery if it seems to be running out of power sooner than it should. Please use the original lithium battery.

- a) Turn the motor handpiece power off.
- b) Use tweezers etc. to open the rubber cover and then remove the screw.
- c) Remove the battery cover.
- d) Remove the old battery and disconnect the connector.
- e) Connect the new battery and put it in the motor handpiece.
- f) Replace the cover and its screw.

It is recommended to contact local distributors or manufacturer to replace the battery.

4.11 Oiling of contra angle

Only the original oil injection nozzle can be used for oiling of contra angle. The contra angle needs to be lubricated after cleaning and disinfection, but before sterilization.

1. Firstly, screw the injecting nozzle into jet of oil bottle. (Around 1 to 3 circles)
2. Next, plug the nozzle into the end part of contra angle, and then

grease the contra angle for 2-3s till the oil flow out of contra angle head part.

3. Vertically place the end part of contra angle more than 30 minutes to let go the redundant oil under gravity.

⚠ Warnings

Motor handpiece cannot be filled with oil.

⚠ Cautions

a: To avoid the contra angle from flying out for the pressure, use hand to safely hold the contra angle while greasing.

b: Do not use a swirling nozzle. Swing nozzle can only be used for injection of gas, not for oiling.

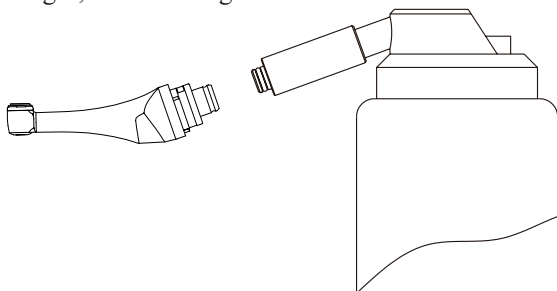

5 Troubleshooting

Failure	Possible cause	Solutions
The motor handpiece does not rotate.	Chose EAL mode, EAL mode is only for canal measurement.	Changing to CW, CCW, SGP or ATR mode.
There is continuous beep sounds after starting the motor handpiece.	The continuous beep sound is indicating that the motor handpiece is under CCW mode.	Stop the motor handpiece and change the operating mode to CW Mode.
Contra angle calibration failure	Calibration failure caused by strong resistance of contra angle	Clean the contra angle, and recalibrate after oil injection.
The time of endurance becomes shorter after charging.	Battery capacity becomes smaller.	Please contact local distributor or manufacturer.

No sound	Beeper Volume set to 0. Vol.0: Mute.	Set Beeper Volume to 1,2,3.
The continuously rotating file is stuck at the root canal.	Incorrect specification setting. Too high load torque of file.	Choose CCW Mode, start the motor handpiece, and take the file out.

6 Cleaning, Disinfection and Sterilization

6.1 Foreword

For hygiene and sanitary safety purposes, the contra-angle, the lip hook, the file clip, the protective silicon cover and the touch probe must be cleaned, disinfected and sterilized before each usage to prevent any contamination. This concerns the first use, as well as all subsequent uses.

6.2 General recommendations

6.2.1 Use only a disinfecting solution which is approved for its efficacy (VAH/DGHM-listing, CE marking, FDA and Health Canada approval) and in accordance with the DFU of the disinfecting solution manufacturer.

6.2.2 Do not place the contra-angle in a disinfectant solution or in an ultrasonic bath.

Do not use chloride detergent materials.

6.2.3 Do not use bleach or chloride disinfectant materials.

6.2.4 For your own safety, please wear personal protective equipment (gloves, glasses, mask).

6.2.5 The user is responsible for the sterility of the product for the first cycle and each further usage as well as for the usage of damaged or dirty instruments where applicable after sterility.

6.2.6 The water quality has to be convenient to the local regulations especially for the last rinsing step or with a washer-disinfector.

6.2.7 To sterilize the endodontic files, refer to the manufacturer's instructions for use.

6.2.8 The contra-angle needs to be lubricated after cleaning and disinfection, but before sterilization.

6.3 Cleaning and disinfection steps for the motor handpiece, the AC adapter and the base.

Before and After each use, all the objects that were in contact with

infectious agents should be cleaned using towels impregnated with a disinfecting and detergent solution (a bactericidal, fungicidal and aldehyde free solution) approved by VAH/DGHM-listing, CE marking, FDA and Health Canada.



Warning: Do not sterilize the motor handpiece, the AC adapter and the base.

6.3.1 Pre-Op processing

Before each use, the handpiece, charger, and base must be cleaned and disinfected. The specific steps are as follows:



Warning: The handpiece, charger, and base cannot be cleaned and disinfected with automatic equipment. Manual cleaning and disinfection is required.

6.3.1.1 Manual cleaning steps:

1. Take out the handpiece, charger, and base on the workbench.
2. Wet the soft cloth completely with distilled water or deionized water, and then wipe all the surfaces of the components such as the handpiece, charger, base, etc. until the surface of the component is not stained.
3. Wipe the surface of the component with a dry soft nap-free cloth.
4. Repeat the above steps at least 3 times.

Note:

a) Use distilled water or deionized water for cleaning at room temperature.

6.3.1.2 Manual disinfection steps:

1. Soak the dry soft cloth with 75% alcohol.
2. Wipe all surfaces of headpiece, charger, base and other components with a wet soft cloth for at least 3 minutes.
3. Wipe the surface of the component with a dry soft nap-free cloth.

Note:

a) The cleaning and disinfection must be performed within 10min before use.

b) The disinfectant used must be used immediately, no foaming is allowed.

c) In addition to 75% alcohol, you can use non-residue disinfectants such as Oxytech from Germany, but you must respect the concentration, temperature and time specified by the disinfectant manufacturer.

d) After cleaning and disinfecting the handpiece, you must install a disposable isolation sleeve before use and repeat steps 1, 2 and 3 to clean the disposable isolation sleeve (For detailed installation steps, see section 2.7).

6.3.2 Post-Op processing

After each use, clean and disinfect the handpiece, charger, and base within 30 minutes. The specific steps are as follows:

Tools: Nap-free soft cloth, tray

1. Remove the contra-angle from the handpiece, place it in a clean tray, and then remove the disposable isolation sleeve from the handpiece.

2. Soak the nap-free soft cloth with distilled water or deionized water, and then wipe all the surfaces of the components such as the handpiece, charger, base, etc. until the surface of the component is not stained.

3. Wet the dry soft cloth with 75% alcohol, and then wipe all surfaces of the handpiece, charger, base and other components for 3 minutes.

4. Put the handpiece, charger, base and other components back into the clean storage area.

Note:

a) The cleaning and disinfection must be performed within 10min before use.

b) The disinfectant used must be used immediately, no foaming is allowed.

c) In addition to 75% alcohol, you can use non-residue disinfectants such as Oxytech from Germany, but you must respect the concentration, temperature and time specified by the disinfectant manufacturer.

6.4 The cleaning, disinfection and sterilization of contra-angle, lip hook, file clip, protective silicon cover, touch probe are as follow.

Unless otherwise stated, they will be hereinafter referred to as “products”.

Warnings:

The use of strong detergent and disinfectant (alkaline pH>9 or acid pH <5) will reduce the life span of products. And in such cases, the manufacturer takes no responsibility.

The products may not be exposed to temperature above 138°C.

Processing limit

The products have been designed for a large number of sterilization

cycles. The materials used in manufacture were selected accordingly. However with every renewed preparation for use, thermal and chemical stresses will result in ageing of the products. The maximum number of sterilizations for products is 250 times.

6.4.1 Initial processing

6.4.1.1 Processing principles

It is only possible to carry out effective sterilization after the completion of effective cleaning and disinfection. Please ensure that, as part of your responsibility for the sterility of products during use, only sufficiently validated equipment and product-specific procedures are used for cleaning/disinfection and sterilization, and that the validated parameters are adhered to during every cycle.

Please also observe the applicable legal requirements in your country as well as the hygiene regulations of the hospital or clinic, especially with regard to the additional requirements for the inactivation of prions.

6.4.1.2 Post-operative treatment

The post-operative treatment must be carried out immediately, no later than 30 minutes after the completion of the operation. The steps are as follows:

1. Remove the products from the base, and rinse away the dirt on the surface of handpiece with pure water (or distilled water/deionized water);
2. Dry the products with a clean, soft cloth and place it in a clean tray.

Notes:

- a) The water used here must be pure water, distilled water or deionized water.

6.4.2 Preparation before cleaning

Steps:

Tools: tray, soft brush, clean and dry soft cloth.

1. Remove the shanks/files.
2. Remove the file clip, isolation sleeve, Contra-angle and connecting wire from the handpiece in sequence, and then put them into a clean tray;
3. Use a clean soft brush to carefully brush lip hook, file clip, protective silicon cover, touch probe, head and back cover of the contra-angle until the dirt on surface is not visible. Then use soft cloth to dry the products and put them into a clean tray. The cleaning agent can be pure

water, distilled water or deionized water.

Disassembling steps

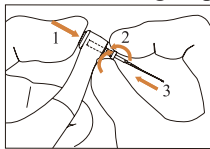

(a)



(b)



(c)

a) Press the push-button and pull out the shank/file.

b) When removing the protective silicon cover, pull it straight out slowly.

c) When inserting and removing the contra-angle, turn the handpiece power off beforehand.

6.4.3 Cleaning

The cleaning should be performed no later than 24 hours after the operation.

The cleaning can be divided into automated cleaning and manual cleaning. Automated cleaning is preferred if conditions permit.

6.4.3.1 Automated cleaning

- The cleaner is proved to be valid by CE certification in accordance with EN ISO 15883.
- There should be a flushing connector connected to the inner cavity of the product.
- The cleaning procedure is suitable for the product, and the irrigating period is sufficient.

It is recommended to use a washer-disinfector in accordance with EN ISO 15883. For the specific procedure, please refer to the automated disinfection section in the next section "Disinfection".

Notes:

a) The cleaning agent does not have to be pure water. It can be distilled water, deionized water or multi-enzyme. But please ensure that the

selected cleaning agent is compatible with the product.

b) In washing stage, the water temperature should not exceed 45 °C, otherwise the protein will solidify and it would be difficult to remove.

c) After cleaning, the chemical residue should be less than 10mg / L.

6.4.4 Disinfection

Disinfection must be performed no later than 2 hours after the cleaning phase. Automated disinfection is preferred if conditions permit.

6.4.4.1 Automated disinfection-Washer-disinfector

·The washer-disinfector is proved to be valid by CE certification in accordance with EN ISO 15883.

·Use high temperature disinfection function. The temperature does not exceed 134 ° C, and the disinfection under the temperature cannot exceed 20 minutes.

·The disinfection cycle is in accordance with the disinfection cycle in EN ISO 15883.

Cleaning and disinfecting steps by using Washer-disinfector

1. Carefully place the product into the disinfection basket. Fixation of product is needed only when the product is removable in the device. The products are not allowed to contact each other.

2. Use a suitable rinsing adaptor, and connect the internal water lines to the rinsing connection of the washer-disinfector.

3. Start the program.

4. After the program is finished, remove the product from the washer-disinfector, inspect (refer to section "Inspection and Maintenance") and packaging (refer to chapter "Packaging"). Dry the product repeatedly if necessary (refer to section "Drying").

Notes:

a) Before use, you must carefully read the operating instructions provided by the equipment manufacturer to familiarize yourself with the disinfection process and precautions.

b) With this equipment, cleaning, disinfection and drying will be carried out together.

c) Cleaning: (c1) The cleaning procedure should be suitable for the product to be treated. The flushing period should be sufficient (5-10 minutes). Pre-wash for 3 minutes, wash for another 5 minutes, and rinse it for twice with each rinse lasting for 1 minute. (c2) In the washing stage, the water temperature should not exceed 45 °C, otherwise the protein will solidify and it is difficult to remove. (c3)

The solution used can be pure water, distilled water, deionized water or multi-enzyme solution, etc., and only freshly prepared solutions can be used. (c4) During the use of cleaner, the concentration and time provided by manufacturer shall be obeyed. The used cleaner is neodisher MediZym (Dr. Weigert).

d) Disinfection: (d1) Direct use after disinfection: temperature $\geq 90^{\circ}\text{C}$, time ≥ 5 min or $A0 \geq 3000$;

Sterilize it after disinfection and use: temperature $\geq 90^{\circ}\text{C}$, time ≥ 1 min or $A0 \geq 600$

(d2) For the disinfection here, the temperature is 93°C , the time is 2.5 min, and $A0 > 3000$

e) Only distilled or deionized water with a small amount of microorganisms (< 10 cfu/ml) can be used for all rinsing steps. (For example, pure water that is in accordance with the European Pharmacopoeia or the United States Pharmacopoeia).

f) After cleaning, the chemical residue should be less than 10mg/L .

g) The air used for drying must be filtered by HEPA.

h) Regularly repair and inspect the disinfectant.

6.4.5 Drying

If your cleaning and disinfection process does not have an automatic drying function, dry it after cleaning and disinfection.

Methods:

1. Spread a clean white paper (white cloth) on the flat table, point the product against the white paper (white cloth), and then dry the product with filtered dry compressed air (maximum pressure 3 bar). Until no liquid is sprayed onto the white paper (white cloth), the product drying is completed.

2. It can also be dried directly in a medical drying cabinet (or oven). The recommended drying temperature is $80^{\circ}\text{C} \sim 120^{\circ}\text{C}$ and the time should be 15~40 minutes.

Notes:

a) The drying of product must be performed in a clean place.

b) The drying temperature should not exceed 138°C ;

c) The equipment used should be inspected and maintained regularly.

6.4.6 Inspection and maintenance

6.4.6.1 Inspection

In this chapter, we only check the appearance of the product.

1. Check the product. If there is still visible stain on the product after

cleaning/disinfection, the entire cleaning/disinfection process must be repeated.

2. Check the product. If it is obviously damaged, smashed, detached, corroded or bent, it must be scrapped and not allowed to continue to be used.

3. Check the product. If the accessories are found to be damaged, please replace it before use. And the new accessories for replacement must be cleaned, disinfected and dried.

4. If the service time (number of times) of the product reaches the specified service life (number of times), please replace it in time.

6.4.6.2 Maintenance

Sterilizable Oil lubrication shall be applied to dried contra angle.

The nozzle of cleaning lubricant is aligned with the air intake hole at the end of the contra angle to inject oil for 1-2 seconds.

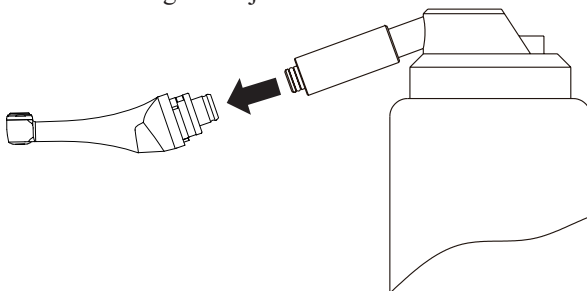

6.4.7 Packaging

Install the disinfected and dried product and quickly package it in a medical sterilization bag (FDA cleared wrap or pouch).

Notes:

- a) The package used conforms to ISO 11607;
- b) It can withstand high temperature of 138 °C and has sufficient steam permeability;
- c) The packaging environment and related tools must be cleaned regularly to ensure cleanliness and prevent the introduction of contaminants;
- d) Avoid contact with parts of different metals when packaging.

6.4.8 Sterilization

Use only the following steam sterilization procedures (fractional pre-vacuum procedure*) for sterilization, and other sterilization procedures are prohibited:

·The steam sterilizer complies with EN13060 or is certified according to EN 285 to comply with EN ISO 17665 or is cleared by FDA.

·The highest sterilization temperature is 138 ° C;

The validated sterilization cycle is one (1) fraction cycle, three (3) consecutive half cycle and one (1) full cycle. The parameters are provided in the table below.

Mode	Vacuum	Temperature	Cycle	Exposure Time	Drying Time
PreVac	- 80 kPa	(132-134) °C	Fraction	30 seconds	20 minutes
			Half 1	2 minutes	20 minutes
			Half 2	2 minutes	20 minutes
			Half 3	2 minutes	20 minutes
			Full	4 minutes	20 minutes

Verification of the fundamental suitability of the products for effective steam sterilization was provided by a verified testing laboratory.

Notes:

a) Only products that have been effectively cleaned and disinfected are allowed to be sterilized;

b) Before using the sterilizer for sterilization, read the Instruction Manual provided by the equipment manufacturer and follow the instructions.

c) Do not use hot air sterilization and radiation sterilization as this may result in damage to the product;

d) Please use the recommended sterilization procedures for sterilization. It is not recommended to sterilize with other sterilization procedures such as ethylene oxide, formaldehyde and low temperature plasma sterilization. The manufacturer assumes no responsibility for the procedures that have not been recommended. If you use the sterilization procedures that have not been recommended, please adhere to related effective standards and verify the suitability and effectiveness.

* Fractional pre-vacuum procedure = steam sterilization with repetitive pre-vacuum. The procedure used here is to perform steam sterilization through three pre-vacuums.

6.4.9 Storage

1. Store in a clean, dry, ventilated, non-corrosive atmosphere with a relative humidity of 10% to 93%, an atmospheric pressure of 70KPa to

106kPa, and a temperature of -20 °C to +55 °C;

2. After sterilization, the product should be packaged in a medical sterilization bag or a clean sealing container, and stored in a special storage cabinet. The storage time should not exceed 7 days. If it is exceeded, it should be reprocessed before use.

Notes:

a) The storage environment should be clean and must be disinfected regularly;

b) Product storage must be batched and marked and recorded.

6.4.10 Transportation

1. Prevent excessive shock and vibration during transportation, and handle with care;

2. It should not be mixed with dangerous goods during transportation.

3. Avoid exposure to sun or rain or snow during transportation.

7 Storage, maintenance and transportation

7.1 Storage

7.1.1 This equipment should be stored in a room where the relative humidity is 10% ~ 93%, atmospheric pressure is 70kPa to 106kPa, and the temperature is -20°C ~ +55°C.

7.1.2 Avoid the storage in a too hot condition. High temperature will shorten the life of electronic components, damage battery, reshape or melt some plastic.

7.1.3 Avoid the storage in a too cold condition. Otherwise, when the temperature of the equipment increases to a normal level, there will be dew that will possibly damage PCB board.

7.2 Maintenance

7.2.1 This device do not include accessories for repair usage, the repair should be carried out by authorized person or authorized after service center.

7.2.2 Keep the equipment in a dry storage condition.

7.2.3 Do not throw, beat or shock the equipment.

7.2.4 Do not smear the equipment with pigments.

7.2.5 Calibration is recommended when using a new/other contra angle or after an extend period of operation, as the running properties can change with usage, cleaning and sterilization.

7.2.6 Replace the battery if it seems to be running out of power sooner

than it should.

7.3 Transportation

7.3.1 Excessive impact and shake should be prevented in transportation. Lay it carefully and lightly and don't invert it.

7.3.2 Don't put it together with dangerous goods during transportation.

7.3.3 Avoid solarization and getting wet in rain and snow during transportation.

8 Environmental protection

Please dispose according to the local laws.













9 After service

From the date this equipment has been sold, based on the warranty card, we will repair this equipment free of charge if there are quality problems. Please refer to the warranty card for the warranty period.

10 European authorized representative

EC REP MedNet EC-Rep GmbH
Borkstrasse 10 · 48163 Muenster · Germany

11 Symbol instruction

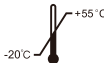
	Follow Instructions for Use		Serial number
	Date of manufacture		Manufacturer
	Type B applied part		Class II equipment
IPX0	Ordinary equipment		Recovery
	Used indoor only		Keep dry
	Handle with care		Appliance compliance WEEE directive
	Humidity limitation		Temperature limitation



Atmospheric
pressure for storage



0197 CE marked product



Authorised Representative in the EUROPEAN
COMMUNITY

12 Statement

All rights of modifying the product are reserved to the manufacturer without further notice. The pictures are only for reference. The final interpretation rights belong to GUILIN WOODPECKER MEDICAL INSTRUMENT CO., LTD. The industrial design, inner structure, etc, have claimed for several patents by WOODPECKER, any copy or fake product must undertake legal responsibilities.

13 EMC-Declaration of conformity

The device has been tested and homologated in accordance with EN 60601-1-2 for EMC. This does not guarantee in any way that this device will not be effected by electromagnetic interference Avoid using the device in high electromagnetic environment.

Technical Description Concerning Electromagnetic Emission

Table 1: Declaration - electromagnetic emissions

Guidance and manufacturer's declaration - electromagnetic emissions		
The model Ai-Motor is intended for use in the electromagnetic environment specified below. The customer or the user of the model Ai-Motor should assure that it is used in such an environment.		
Emissions test	Compliance	Electromagnetic environment - guidance
RF emissions CISPR 11	Group 1	The model Ai-Motor uses RF energy only for its internal function. Therefore, its RF emissions are very low and are not likely to cause any interference in nearby electronic equipment.

RF emissions CISPR11	Class B	The model Ai-Motor is suitable for used in all establishments, including domestic establishments and those directly connected to the public low-voltage power supply network that supplies buildings used for domestic purposes.
Harmonic emissions IEC 61000-3-2	Class A	
Voltage fluctuations / flicker emissions IEC 61000-3-3	Complies	

Technical Description Concerning Electromagnetic Immunity

Table 2: Guidance & Declaration - electromagnetic immunity

Guidance & Declaration — electromagnetic immunity			
The model Ai-Motor is intended for use in the electromagnetic environment specified below. The customer or the user of the model Ai-Motor should assure that It is used in such an environment.			
Immunity test	IEC 60601 test level	Compliance level	Electromagnetic environment - guidance
Electrostatic discharge (ESD) IEC 61000-4-2	±8kV contact ±2, ±4, ±8, ±15kV air	±8kV contact ±2, ±4, ±8, ±15kV air	Floors should be wood, concrete or ceramic tile. If floors are covered with synthetic material, the relative humidity should be at least 30 %.
Electrical fast transient/burst IEC 61000-4-4	±2kV for power supply lines ±1kV for Input/output lines	±2kV for power supply lines	Mains power quality should be that of a typical commercial or hospital environment.
Surge IEC 61000-4-5	±0.5, ±1kV line to line ±0.5, ±1, ±2kV line to earth	±0.5, ±1kV line to line ±0.5, ±1, ±2kV line to earth	Mains power quality should be that of a typical commercial or hospital environment.

Voltage dips, short interruptions and voltage variations on power supply input lines IEC 61000-4-11	<5 % UT (>95% dip in UT.) for 0.5 cycle <5 % UT (>95% dip in UT.) for 1 cycle 70% UT (30% dip in UT) for 25 cycles <5% UT (>95 % dip in UT) for 250 cycles	<5 % UT (>95% dip in UT.) for 0.5 cycle <5 % UT (>95% dip in UT.) for 1 cycle 70% UT (30% dip in UT) for 25 cycles <5% UT (>95 % dip in UT) for 250 cycles	Mains power quality should be that of a typical commercial or hospital environment. If the user of the models Ai-Motor requires continued operation during power mains interruptions, it is recommended that the models Ai-Motor be powered from an uninterruptible power supply or a battery.
Power frequency (50/60 Hz) magnetic field IEC 61000-4-8	30A/m	30A/m	Power frequency magnetic fields should be at levels characteristic of a typical location in a typical commercial or hospital environment.
NOTE UT is the a.c. mains voltage prior to application of the test level.			

Table 3: Guidance & Declaration - electromagnetic immunity concerning Conducted RF & Radiated RF

Guidance & Declaration - Electromagnetic immunity			
The model Ai-Motor is intended for use in the electromagnetic environment specified below. The customer or the user of the models Ai-Motor should assure that it is used in such an environment.			
Immunity test	IEC 60601 test level	Compliance level	Electromagnetic environment - guidance

<p>Conducted RF IEC 61000-4-6</p> <p>Conducted RF IEC 61000-4-6</p> <p>Radiated RF IEC 61000-4-3</p>	<p>3 Vrms 150 kHz to 80 MHz</p> <p>6 Vrms ISM frequency band</p> <p>3 V/m 80 MHz to 2.7 GHz</p>	<p>3V</p> <p>6V</p> <p>3V/m</p>	<p>Portable and mobile RF communications equipment should be used no closer to any part of the models Ai-Motor, including cables, than the recommended separation distance calculated from the equation applicable to the frequency of the transmitter.</p> <p>Recommended separation distance $d=1.2 \times P^{1/2}$ $d=2 \times P^{1/2}$ $d=1.2 \times P^{1/2}$ 80 MHz to 800 MHz $d=2.3 \times P^{1/2}$ 800 MHz to 2.7 GHz</p> <p>where P is the maximum output power rating of the transmitter in watts (W) according to the transmitter manufacturer and d is the recommended separation distance in meters (m).</p> <p>Field strengths from fixed RF transmitters, as determined by an electromagnetic site survey, a should be less than the compliance level in each frequency range. b Interference may occur in the vicinity of equipment marked with the following symbol:</p>
--	---	---------------------------------	---

NOTE 1 At 80 MHz end 800 MHz. the higher frequency range applies.

NOTE 2 These guidelines may not apply in all situations. Electromagnetic propagation is affected by absorption and reflection from structures, objects and people.

a Field strengths from fixed transmitters, such as base stations for radio (cellular/cordless) telephones and land mobile radios, amateur radio, AM and FM radio broadcast and TV broadcast cannot be predicted theoretically with accuracy. To assess the electromagnetic environment due to fixed RF transmitters, an electromagnetic site survey should be considered. If the measured field strength in the location in which the model Ai-Motor is used exceeds the applicable RF compliance level above, the model Ai-Motor should be observed to verify normal operation. If abnormal performance is observed, additional measures may be necessary, such as reorienting or relocating the model Ai-Motor.

b Over the frequency range 150 kHz to 80 MHz, field strengths should be less than 3V/m.

Table 4: Recommended separation distances between portable and mobile RF communications equipment and the model Ai-Motor

Recommended separation distances between portable and mobile RF communications equipment and the model Ai-Motor			
The model Ai-Motor is intended for use in electromagnetic environment in which radiated RF disturbances is controlled. The customer or the user of the model Ai-Motor can help prevent electromagnetic interference by maintaining a minimum distance between portable and mobile RF communications equipment (transmitters) and the model Ai-Motor as recommended below, according to the maximum output power of the communications equipment.			
Rated maximum output power of transmitter W	Separation distance according to frequency of transmitter m		
	150kHz to 80MHz $d=1.2 \times P^{1/2}$	80MHz to 800MHz $d=1.2 \times P^{1/2}$	800MHz to 2,7GHz $d=2.3 \times P^{1/2}$
0,01	0.12	0.12	0.23
0,1	0.38	0.38	0.73
1	1.2	1.2	2.3
10	3.8	3.8	7.3
100	12	12	23
For transmitters rated at a maximum output power not listed above, the recommended separation distance d in meters (m) can be estimated using the equation applicable to the frequency of the transmitter, where P is the maximum output power rating of the transmitter in watts (W) accordable to the transmitter manufacturer.			
NOTE 1 At 80 MHz and 800 MHz. the separation distance for the higher frequency range applies.			
NOTE 2 These guidelines may not apply in all situations. Electromagnetic propagation is affected by absorption and reflection from structures, objects and people.			

Scan and Login website
for more information



Guilin Woodpecker Medical Instrument Co., Ltd.
Information Industrial Park, Guilin National High-Tech
Zone, Guilin, Guangxi, 541004 P. R. China
Sales Dept.: +86-773-5873196
[Http://www.glwoodpecker.com](http://www.glwoodpecker.com)
E-mail: woodpecker@glwoodpecker.com



MedNet EC-Rep GmbH
Borkstrasse 10 · 48163 Muenster · Germany

ZMN-SM-081 V1.0-20220419